

# CASYS

## *International Journal of Computing Anticipatory Systems*

Edited by Daniel M. Dubois

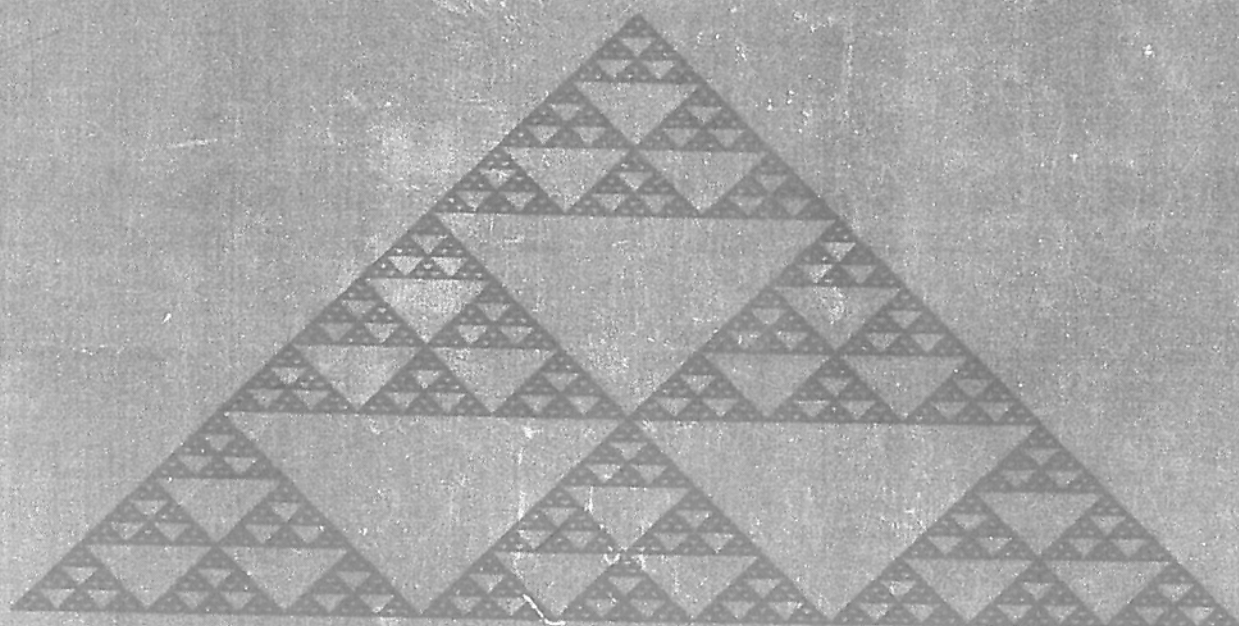

**VOLUME 5**

**Relativist and Non-linear Physical Systems  
Biological, Ecological and Autonomous Systems  
Anticipatory Business and Economics**

*Published by CHAOS*

# THE DOUBLING THEORY

By Jean-Pierre Garnier-Malet

Paris - France

E-mail : [jpgarma@free.fr](mailto:jpgarma@free.fr)

## Abstract

This communication is the continuation of two papers (Garnier-Malet, 1998, 1999) which proposed a new model with several essential distinctive features. First, the observations are consequences of the universal principle of horizons and virtual motions of a system of spaces' horizons, which limits observations and interactions. Then, time is stroboscopic with periodical times of observation or interaction and periodical times of non-observation or non-observable interaction.

This theoretical model dispose of basic notions and principles, however it never disposes of the existing laws. It introduces a set of periodical motions of embedded horizons, which would be fundamental for physics, as well for quantum mechanics as for relativistic mechanics.

An application to the solar system (Garnier-Malet J.P., 1998) gave us the understanding of the physical reality of this geometry. It allowed us to explain in another way Kepler's three laws and the motion of planetary libration. It also allowed us to rediscover the condition of the relativity theory in the solar system (the precessional motion of Mercury's orbit).

This new model implies one solar cycle (24 840 years), which is going now to end (2017). Above all, it causes a junction between our solar system and the speed of light, which I could calculate in a theoretical way. It gives me now the capability to propound a new theorem, which is already verified by two important astronomic observations.

## Keywords

Embedded particles or horizons, stroboscopic time, temporal holes and windows, radial and tangential paths, anticipative doubling, hyperincursion.

## 1 Introduction

Any space (small dust, atom, star, galaxy or Universe) may be considered as an observable and interactive space in a horizon of events. In this model, any horizon, which limits interactions of an observable particle, is also a particle in another horizon. Another important peculiarity of this model is the fact that a horizon (or a particle) is tangentially moving on another horizon (or particle). These relative motions of horizons and particles construct new frames of reference in a dynamic way. We shall see that they forbid all rectilinear propagation. However, it is out of question to abandon the habitual notion of rectilinear propagation. A rectilinear (or curved) trajectory will always be the result of a succession of observations, made in a stroboscopic way on a privileged axis (rectilinear or curve). Actually, we assume that the observable time

flows in a stroboscopic way : times of perception alternate with times of non-perception. Einstein was already talking about this cutting out of time (see the four conferences about the relativity theory, 1921, at Princeton). The fundamental notions that I bring to this new model, give concrete form to this basic idea of Einstein.

Time, which is measured in a continuous way by the clock, is only a succession of denumerable times, which implies a "before" and an "after" of each state of observation. The definition of a non-perception state assumes that the observer cannot observe an observable event. This observer does not know the real space but only the observed space by a succession of subjective perception states. The "flow of time" can be differentiated between two particles, which take place into two different horizons.

A particle will be connected to a first frame of reference (into its horizon), to a second frame of reference (where its horizon is a particle) and to a third frame of reference (where it is the horizon of another particle). So, the particle's energy is always the consequence of three embedded energies : the new theorem (matter of this paper) will give us their ratios (1/1000, 333/1000 and 666/1000).

We shall see that observations of supernova, made by scientists (Perlmutter S. in America and Schmidt B. in Australia, January 1998) confirm this basic theorem.

Before this demonstration, I am going to explain the system of periodical motions of particles and horizons again (according to the above principles). Called "fundamental motion", these motions use one particle (connected to its threefold frame of reference) to define and measure the space and the time in its horizon. Three embedded horizons allow us to study three temporal states of one particle (past, present, future) in the same event. Three embedded velocities define this embedding (Garnier-Malet, 1999) :

$$C_0 = 7C_1 = (7^3/12)10^5 C_2 \quad (C_2 = \text{speed of light} = 299\,792 \text{ km/s.})$$

To understand the aim of the fundamental motion, which (for the first time) allows us to calculate  $C_2$  in a theoretical way, it would be good to see the notions and principles of this new model again.

## 2 Stroboscopic Time

A real particle  $o_n$  (figure 1) is observed in its event's horizon  $\Omega_n$  where it is interactive. A virtual particle  $o_0$  (non-observable into  $\Omega_n$ ) can be interactive with  $\Omega_n$  or  $o_n$ . It can be observable in  $\Omega_n$  by its interaction or becomes real when it is observed in the horizon of observation.  $o_n$  is an "internal" particle of  $\Omega_n$  and  $o_0$  is an "external" particle of  $\Omega_n$  (interactive into  $\Omega_0$  which is a particle in another horizon  $\Omega_e$ ). So,  $o_0$  is an "intermediate" particle between an "internal" particle  $o_n$  and an "external" particle  $o_e$ .

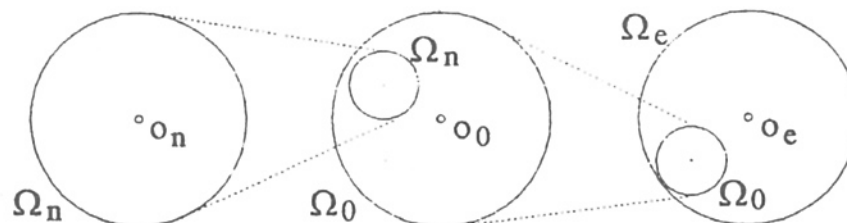

**Figure 1** : three embedded horizons (or particles).

For  $o_n$ ,  $\Omega_n$  is a boundary of observable events and interactions.

It is a minimum threshold for  $o_0$  which interacts with  $\Omega_n$  into its horizon  $\Omega_0$  and a maximum for  $o_n$  which interacts into its horizon  $\Omega_n$ .

Each horizon has privileged directions of observation (a direction of propagation or interaction) : in a three-dimensional observable space, the association of two virtual particles (internal and external) with each real particle (intermediate), builds a "Threefold Frame of Reference". With this TFR, the distance  $R$ , the time  $T$  or the rotation  $\Theta$ , always will be the distance  $R$ , the time  $T$  or the rotation  $\Theta$  into the horizon  $\Omega_n$  of a particle  $o_n$  and so noticed :  $(R)_n$ ,  $(T)_n$  or  $(\Theta)_n$ .

So,  $(R_0)_n$  will be a distance  $R$  into the horizon of  $o_0$ , observable into the horizon of  $o_n$ .

The time is dotted : its "flow" is stroboscopic (figure 2).

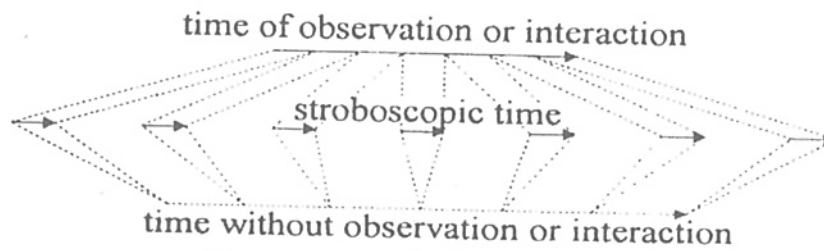

**Figure 2** : stroboscopic time.

There are "temporal holes" where the particle is not interactive and seems to be at rest.

There are "temporal windows" where the particle can interact.

The particle is only observable during a temporal window.

The motion of a particle during a temporal hole is non-observable in this horizon. So, the propagation of this particle is only an appearance in its horizon : it could be curved in the temporal holes and rectilinear in the temporal windows or conversely.

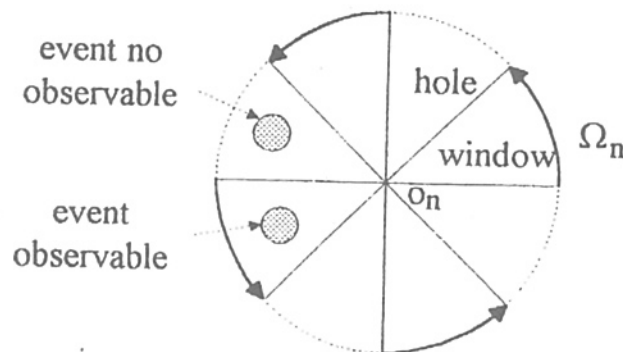

**Figure 3** : schema of periodical motion into a horizon.

The "opening's times" of temporal windows and holes into a horizon are defined by a periodical motion of a particle into this horizon which is always a particle in another horizon. Consequently, this motion of particles must also be the motion of horizons.

This periodical and fundamental motion defines and distinguishes the flow of time into any horizon  $\Omega_n$  of any real or virtual, internal, intermediate or external particle  $o_n$ .

So, a particle, which would be able to enter into another horizon during a temporal hole, could obtain the time's flow of this new horizon. By definition of the temporal hole, this

exchange would be non-observable into the initial horizon, but the resulting interactions instantaneously would modify its observable behavior. In fact, an observable interaction is possible in the second horizon where the flow of time is different. But the result of this interaction into the initial horizon appears to be instantaneous.

So, this exchange of horizons can give us an impression of instantaneous acceleration or deceleration of the motion of particles because only a part of this motion is observable into the initial horizon. A real or virtual particle, moving in stroboscopic time, can obtain the instantaneous result of an interaction in a temporal hole of its horizon by exchanging its horizon and the horizon of an internal virtual particle (figure 4).

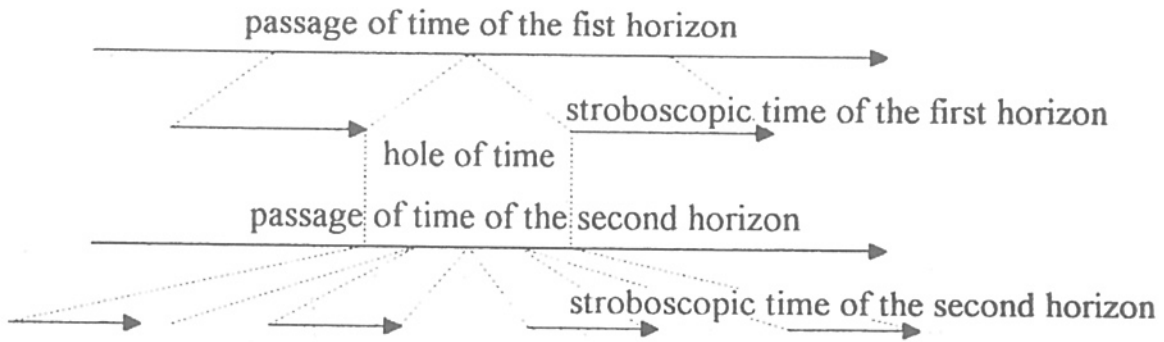
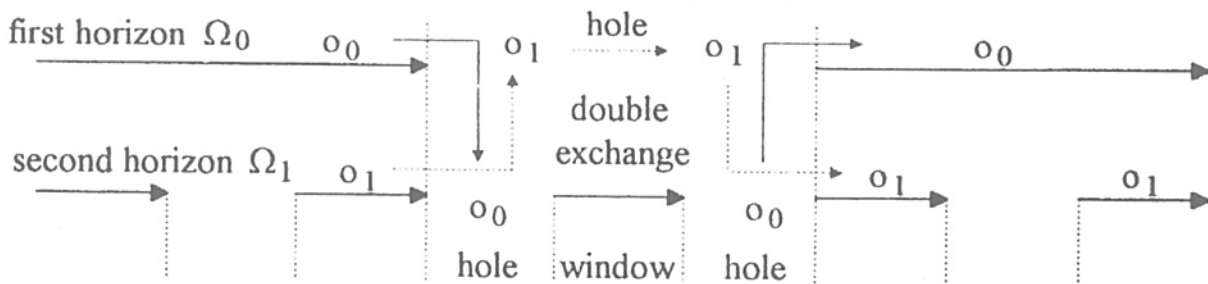

**Figure 4 :** observation in a temporal hole.

A virtual or real particle interacts with the particles which are in its horizon (condition of space), during its temporal windows (condition of time). So, an exchange of horizons between two particles, during the temporal holes of their respective horizons, is not observable in these horizons. After the exchange, the initial particle can find its initial state again into its initial horizon. In this case, this exchange is not observable. However, the particle has been transformed by an interaction outside its horizon.

This "external" interaction gives to the particle many "information" (distance, rotation, translation velocity,...), which are analyzed according to its Threefold Frame of Reference. These information will be recognized when the particle finds the same spatial and temporal condition again in its TFR.

During a first exchange within a temporal hole of a horizon  $\Omega_0$ , the particle  $o_0$  of  $\Omega_0$  can use a temporal window of a second horizon  $\Omega_1$  (figure 5).

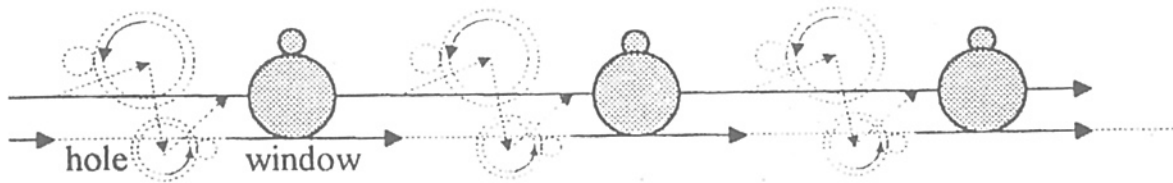

**Figure 5 :** the double exchange.

This temporal window into  $\Omega_1$  gives real information to  $o_0$ , but the time of this reality does not exist in the temporal hole in  $\Omega_0$ . When  $o_0$  finds its initial horizon  $\Omega_0$  again in

its next temporal window, these information become instantaneous because, by definition, the interactions, which come from a temporal hole, are not observable in this horizon. In other words, we can say that information, which is coming from a temporal hole of the particle's horizon, is immediately memorized by the particle in the next temporal window of its horizon.

In fact, the interactions of particles depend on the relative position of their respective horizons, which can interact in a common horizon  $\Omega_0$ . So, this new model must verify the well-known laws of particles' interactions. When two particles have a common horizon and when their temporal windows coincide, they are interactive according to their known physical proprieties. But we must not forget the interactions during the temporal holes where we find these proprieties again. So, the immobility of a particle is only an appearance into its horizon (figure 6).



**Figure 6 :** agitation and dilation into the holes and immobility into the windows.

In this model, the real or virtual particle is never motionless because its horizon is always an interactive particle into another horizon. The impression of immobility comes from a slowing down of the time's flow : there is never absolute rest. The time and the space can be modified in an independent way within the temporal holes.

So, without observation of this modification within the temporal windows, the continuum space-time is a wrong sense. Einstein's Theory of Relativity uses the temporal windows. A change of spaces' and times' scales must be considered in the temporal holes. But it is not enough. So, we must consider a change in the velocity of the stroboscopic flow of time, according to the embedding of the horizons.

The periodic motion of a particle  $\Omega_n$ , which must define time's flow into a horizon  $\Omega_0$  must become the motion of the horizon  $\Omega_n = \alpha_0$  of another particle  $o_n$ .

So, this motion exchanges the measure of the time of a particle into a horizon and the measure of the dimension of this horizon into another horizon where the time's flow is different. With three embedded horizons (external, intermediate, internal), the external particle (the slow flow of time) measures space and time as well as the internal particle (the fast flow of time). The apparent accelerations of the "motion which defines the different ratios of stroboscopic flows of time", are the consequence of the particles' exchanges.

### 3 Apparent Dilation of Horizon

To realize the exchange of two particles (by juxtaposition of their horizons), conditions of horizons' dilation are necessary. We shall see how the horizon  $\Omega_1$  (so that  $\Omega_0 = 2\Omega_1$ ) can become  $2\Omega_1$  during a temporal hole into the initial horizon  $\Omega_0$  in order to coincide

with  $\Omega_0$  during this temporal hole. In fact,  $\Omega_1$  becomes  $2\Omega_1$  around the particle  $o_0$ . So  $o_0$  have the stroboscopic flow of time of  $o_1$ . In other words,  $o_0$  becomes  $o_1$  but into a horizon two times larger than the horizon of  $o_1$ . At the same time,  $o_1$  becomes  $o_0$  but during a non-observable temporal hole of  $o_0$ . When  $o_1$  comes again into  $\Omega_1$ , at the end of the temporal hole of  $\Omega_0$ , it is going into a temporal hole of  $\Omega_1$ . So,  $o_1$  does not have the time to observe this exchange which is only virtual for it. When  $o_0$  comes into  $\Omega_0$  again, at the end of its temporal hole, its exchange is also non-observable in its next temporal window where the resulting observation seems to be instantaneous : however  $o_0$  can use one or several temporal windows of  $\Omega_1$ .

#### 4 Principle of Anticipation

For the real particle, the spaces 'and times' modification within a temporal hole (that is to say without real appearance into its initial horizon) is the aim of this space's and time's exchange with a virtual internal particle. A temporal hole of its horizon can be a succession of temporal windows and holes into the horizon of the virtual particle. Only an exchange of particles can anticipate information (memorized by the TFR) resulting from an experiment which is developed into a temporal hole of the initial horizon.

After the exchange, the future (coming from temporal windows of the virtual internal particle) is instantaneously coming into the next temporal window of the initial horizon.

We can say that this future has become the instantaneous past of the real particle.

All the temporal windows of the horizon of the virtual particle (which are in the future of the last temporal window of the real particle before the exchange), constitute the instantaneous past of this experiment after the exchange. Because of the particles' exchange, one temporal window of the initial horizon is instantaneously transformed by the immediate result of a long experiment coming from the last temporal hole. It is a real anticipation for the real particle. So, it is possible to say that the present of the real particle is the future, which is the experiment in the temporal hole of a virtual internal particle. The real particle  $o_0$  (which is moving into a slow flow of time) can anticipate the consequence of an event by an exchange of information with a virtual internal particle  $o_1$  (which is into a fast flow of time). It could so modify its past by doing exchanges with a virtual external particle  $o_{-1}$  (which will be into a slow flow of time).

As this exchange takes place during a temporal hole, the virtual internal particle  $o_1$  becoming  $o_0$ , does not modify the horizon of  $o_0$ .

So, when  $o_0$  comes back into its horizon by a reverse exchange, it can change its horizon (or not) by introducing (or not) its last interaction into its own next temporal window.

#### 5 Principle of Hyperincursion of the Future into the Past

Two exchange of particles ( $o_0$  and  $o_1$ ) allow  $o_0$  to anticipate an interaction. Three exchange of particles (external  $o_{-1}$ , intermediate  $o_0$ , internal  $o_1$ ) allows  $o_0$  to introduce the future into the past (hyperincursion) and into the horizon of the initial and intermediate particle. With the faster stroboscopic time of  $o_1$ ,  $o_0$  can do a second

exchange and so receive anticipated information from a second virtual particle  $o_2$  during a temporal hole into the dilated horizon of  $o_1$ . So,  $o_0$  begins the experiment of  $o_2$ , according to the result of the experiment coming from  $o_1$ . Two reverse exchanges put the particles again into their respective horizons. Because of the temporal windows of  $o_2$ ,  $o_0$  knows the future of an experiment of  $o_1$ . But these results are not observable beforehand into the initial horizons of  $o_0$  and  $o_1$ . When  $o_0$  comes back in its initial horizon, the reverse exchange gives  $o_1$  the future of the experiment. So, the past of  $o_1$  is modified by its future and we can say that the external particle  $o_0$  introduces the future (which is the past of the internal particle  $o_2$ ) into the past of the intermediate particle  $o_1$ . The three particles can begin this exchange again, using another common temporal hole. By considering the virtual internal particle  $o_1$  into a temporal hole of  $o_0$ , we can also consider that  $o_0$  is into a temporal hole of a virtual external particle  $o_{-1}$ . So, the problem is to transform (by the same motion) the internal particle  $o_2$  into an external particle  $o_{-1}$ . The last past event of  $o_2$  which is a future consequence of a present event of  $o_0$ , is first a future consequence of a present event of  $o_{-1}$ , already memorized by  $o_0$  into its present. By this "hyperincursion" of the future into the past, the fact becomes the cause.

## 6 Fundamental Doubling Motion

### 6.1 Principle of Doubling

Because of the exchange of three embedded particles ( $o_0$ ,  $o_1$ ,  $o_2$ ), the intermediate particle  $o_1$  becomes in its horizon the present model of a past, memorized by  $o_0$  and experimented in the future by  $o_2$ . In other words, a particle is always doubled by an internal particle into a temporal hole without modifying it into its initial horizon where the time of this doubling is not observable.

This initial particle is also the doubled particle in a temporal hole of an external particle. These two doublings put the future into the past (hyperincursion) and gives an instantaneous potential action to the intermediate particle during its temporal windows. The sequence of these actions forms a present, which, in fact, is a permanent exchange future-past and past-future into temporal holes. So, any particle has the best future information to instantaneously resolve its present problems, which are coming from its past interactions. The system of virtual motions, which are necessary for the periodic exchanges of particles (or horizons), could be called the "fundamental motion of doubling". It is an undulatory and vibratory motion. This motion allows an exchange of three embedded particles into common temporal holes. It defines the stroboscopic flows of time (temporal holes and windows) according to the dimensions of these particles.

### 6.2 Fundamental Motion or Spinback (recall)

The fundamental motion is composed of three simultaneous rotations (figure 7a) :

- 1°) A rotation  $\varphi$  (center  $o_0$ ) of the diameter of  $\Omega_1 = \Omega_0/2$  in the plane of  $\Omega_0$ .
- 2°) A rotation  $\varphi$  of  $\Omega_1$  around this diameter.
- 3°) A rotation  $2\varphi$  of  $\Omega_1$  around itself.



The particle  $\Omega_n = \Omega_0/2^n$  is also a horizon, which is making the same motion into the horizon  $2\Omega_n$  during the path of  $2\Omega_n$  on  $\Omega_0$  (which is called "tangential path"). The rotation  $\varphi = \pi$  is called "spinback" of  $\Omega_0$  (or  $2\Omega_n$ ). The spinback of  $\Omega_0$  corresponds to the spinback of  $2\Omega_n$ , made during the tangential path of  $2\Omega_n$  on  $\Omega_0$ . This spinback of  $2\Omega_n$  is called "tangential spinback".

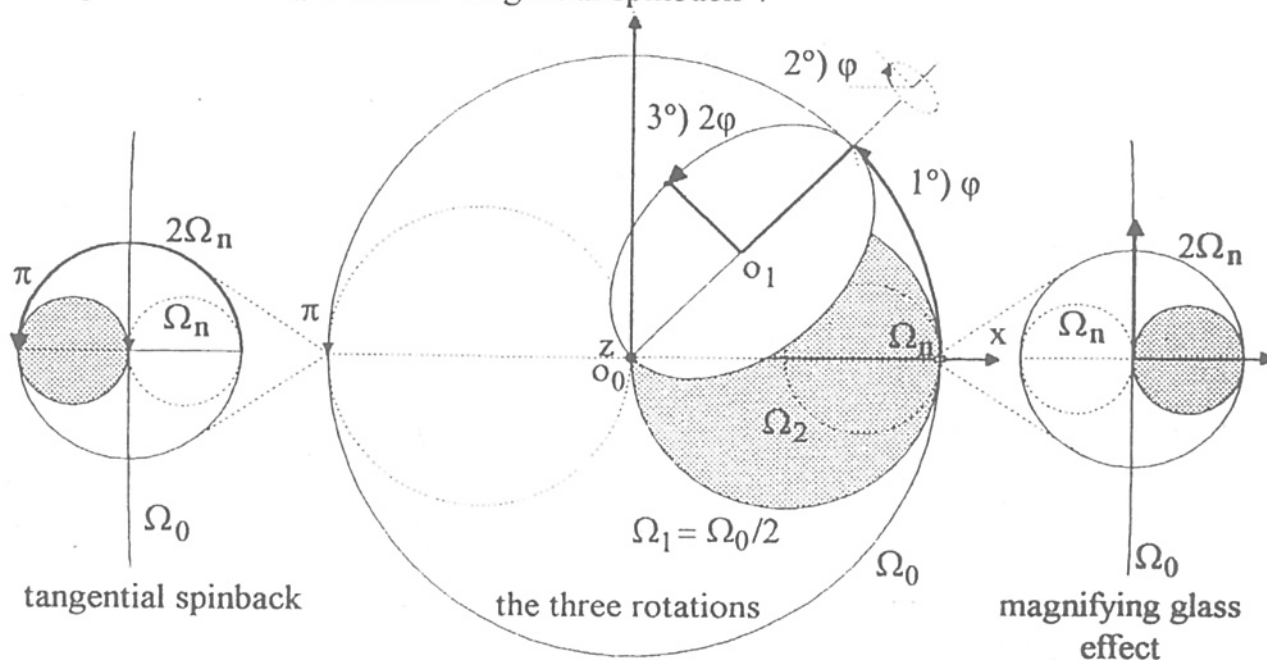

Figure 7a : the fundamental motion or spinback.

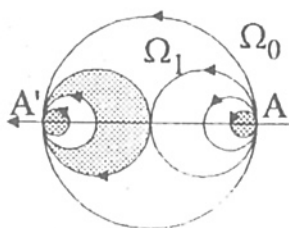

Fig. 7b : spinback of  $\Omega_0$

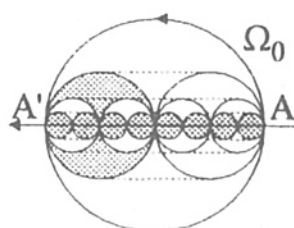

Fig. 7c : radial virtual path

The spinback of  $\Omega_0$  corresponds to 2 spinbacks of  $\Omega_1$  and to  $2^n$  spinbacks of  $\Omega_n$  called "radial spinbacks" into  $\Omega_0$ . It implies a dissociation (or geometrical fission) of horizons  $\Omega_1, \Omega_2, \dots, \Omega_n$  in A, and a reconstitution (or geometrical fusion) in A' (figure 7b.).

It does not give the initial conditions again because it turns back the plane of  $\Omega_1$  into the plane  $\Omega_0$  and in the same sense replaces the other horizons  $\Omega_2, \Omega_3, \dots, \Omega_n$ .

So the paths of  $\Omega_1, \Omega_2, \dots, \Omega_n$  can be considered as "radial paths" into  $\Omega_0$  according to the "radial axis" AA' (figure 7c).

The curve (figure 8a) of the tangential path of a particle on the moving horizon  $\Omega_1$  corresponds to the radial path into  $\Omega_0$ . The parametric equations of this curve are :

$$\begin{aligned}
 x &= \cos^2 \varphi (\cos \varphi - \sin^2 \varphi) \\
 y &= \cos^2 \varphi \sin \varphi (1 + \cos \varphi) \\
 z &= -\cos \varphi \sin^2 \varphi
 \end{aligned}
 \tag{1}$$

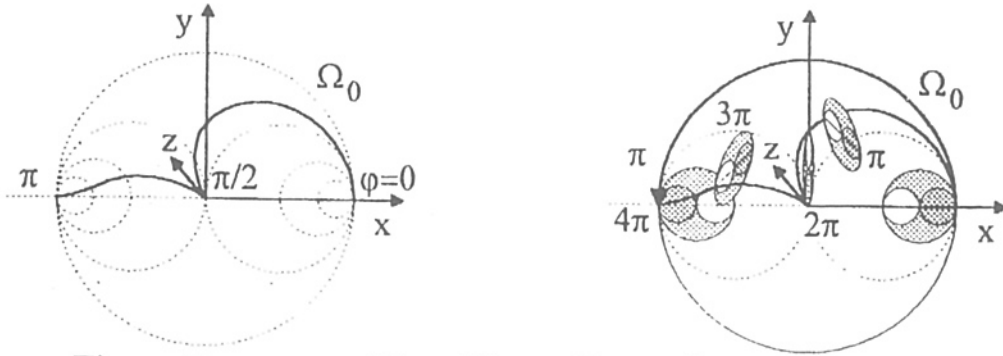

**Figure 8a :** curve (1)      **Figure 8b :** radial path of embedded horizons

This radial curve is not a locus of particles. It carries off a toroid fog of particles during  $2^n$  periodical fission and fusion of the particle  $\Omega_n$  ( $\forall n > 0$ ) which is doing  $2^n$  radial spinbacks during the spinback of  $\Omega_0$  (figure 8b).

According to definitions of the motion which must be the motion of all horizons, the spinback of  $\Omega_0$  into  $2\Omega_0$  corresponds to the rotation  $\pi/2$  of  $2\Omega_0$  on an external horizon  $\Omega_e$  (figure 9).

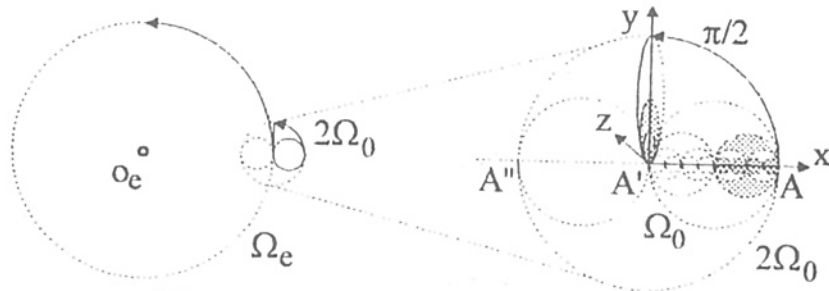

**Figure 9 :** motion of the horizon  $\Omega_0$ .

The radial path (beginning in A) ends in A' on the radial axis AA' of  $2\Omega_0$ . The spinback of  $2\Omega_0$  is a tangential spinback on the horizon  $\Omega_e$  of an external virtual particle  $o_e$ .

So, the radial axis is the same for all the internal virtual particles when the horizon of the external virtual particle  $o_e$  ends its own spinback. However, during this external spinback, the dimension of this radial axis changes according to the stroboscopic flows of the time of the embedded horizons.

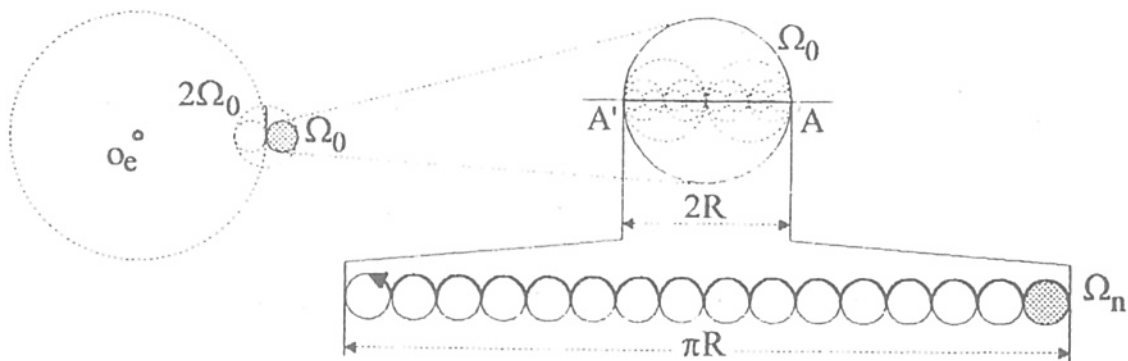

**Figure 10 :** theoretical radial curved axis  $\pi R$  equals observed rectilinear axis  $2R$ .

The path  $AA'$ , radial into  $\Omega_0$  or tangential on  $\Omega_0$ , is equal to  $\pi R$  (figure 10).

By definition, the radius of  $\Omega_n$  is  $R/2^n$  ( $R$  radius of  $\Omega_0$ ). The  $2^n$  spinbacks of  $\Omega_n$  form  $2^n$  tangential paths  $\pi R/2^n$  on  $\Omega_n$  which is the radial path  $\pi R$  into  $\Omega_0$ .

This radial path (during the rotation  $2^n\pi$  of the spinback of  $\Omega_n$ ) occurs with a velocity  $2^n$  times faster than the velocity of the tangential path (during the spinback  $\pi$  of  $\Omega_0$ ).

Radial into  $\Omega_0$  and tangential on  $\Omega_n$ ,  $AA'$  seems to be rectilinear and equals  $2R$  for a large enough  $n$  (figure 10).

The scale's change between external and internal particles must transform  $2R$  into  $\pi R$ . So it must modify the flow of time.

This modification takes place at the end of the spinback of the particles on the axis  $AA'$ . The real initial particle is  $o_0$ . By definition, the virtual external particle  $o_e$  can only be a virtual internal particle  $o_n$ .

This implies that the real tangential path  $\pi R$ , observable into  $\Omega_n$  (during the  $2^n$  spinbacks of  $\Omega_n$ ) becomes a virtual radial path  $2R$ , observable into  $\Omega_0$  with a velocity  $2^n$  times slower.

But the real radial path  $2R$ , observable into  $\Omega_n$  (during the  $2^n$  spinbacks of  $\Omega_n$ ) is also  $2^n$  times slower than the virtual radial path  $2R$ .

So, the velocity of the tangential path on  $\Omega_0$  equals the velocity of the radial path into  $\Omega_n$ . And the external particle  $o_e$  could be the internal particle  $o_{2n}$  of the intermediate particle  $o_n$ . For that, the radial path of  $o_n$  must become the tangential path of  $o_0$ .

This exchange of paths must be realized during the reconstitution of horizons on radial axis, at the end of the spinback of each horizon.

So, a "temporal hole" of  $o_0$  must correspond to the radial spinback of the smallest particle  $\Omega_n$ , which is observable in the horizon  $\Omega_0$ .

### 6.3 Anticipation of Motion

Into  $\Omega_e$ ,  $\Omega_0$  is a particle (figure 11).

The time of a temporal hole into  $\Omega_e$  corresponds to the radial spinback of  $\Omega_0$  and to a tangential spinback of  $2\Omega_n$  on  $\Omega_0$ .

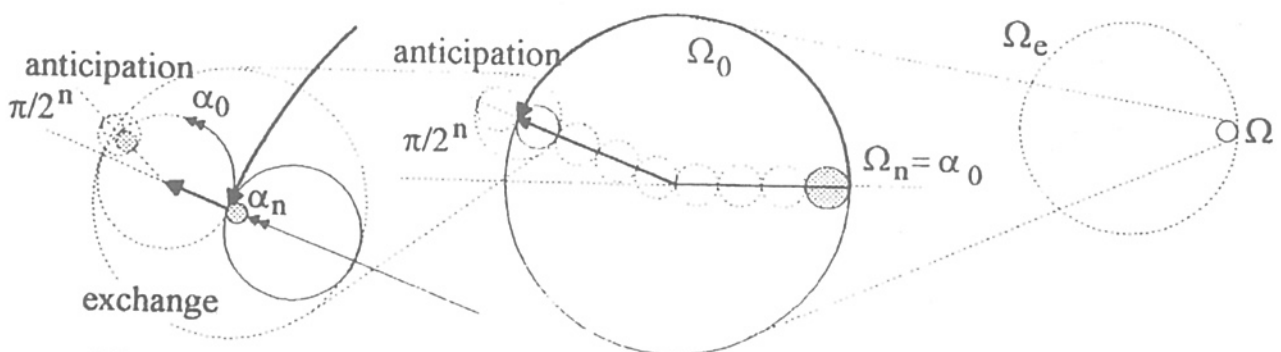

**Figure 11** : anticipation and exchange between radial and tangential paths.

An exchange in a common temporal hole between the internal particle  $\alpha_n$  and the external particle  $\Omega_0$  must be accomplished before the end of this spinback. Within the external particle  $\Omega_0$ , the intermediate particle  $\Omega_n=\alpha_0$  is a horizon for the internal particle  $\alpha_n$ . The non-observable time of a temporal hole in  $\Omega_n$  corresponds to the spinback of  $\alpha_n$ . An exchange in a common temporal hole between the internal and external particles must be done during the spinback of the internal particle.

The spinback of  $\alpha_0$ , which defines temporal holes within  $\Omega_0$ , also defines the flow of time into  $\Omega_0$ . The fundamental motion allows the internal particle  $\alpha_n$  to begin its spinback before the end of the spinback of the external particle  $\Omega_0$ .

So, the exchange of three particles (external, intermediate, and internal) is possible during a common temporal hole.

In fact, it is the exchange of radial and tangential paths that implies the exchange of the particles. This can be realized before the end of the spinback of  $\Omega_0$ .

This exchange is possible when the particle  $\Omega_n$  becomes  $2^n\Omega_n=\Omega_0$  by a dilation. The dilation (Garnier-Malet J.P., 1998, 1999) is in fact a succession of expansions of the embedded horizons, which allows particles to exchange their respective horizons.

When the initial horizon  $\Omega_0$  ends its tangential spinbacks on  $\Omega_e$  into  $2\Omega_0$  (figure 11), the virtual external horizon  $\Omega_e$  end its own spinback. The doubling transformation ends.

The application to the solar system (Garnier-Malet J.P., 1998, 1999) shows us that this end uses six periods from 1899 to 2017. The solar modifications and the planetary warming are signs of this six times end.

#### 6.4 Successive Dilation of the Horizon (recall)

To go into a temporal hole of the internal virtual particle  $o_{-1}$  (defined by the spinback of  $\Omega_0$ ), the real particle  $o_0$  must leave by using the motion of  $\Omega_1$ , during the first spinback of  $\Omega_1$ . So it comes into the center of the  $2\Omega_n$  (figure 12a).

This spinback (during the rotation  $\pi/2$  of the diameter of  $\Omega_1$ ) exchanges the virtual particle  $o_1$  and the real particle  $o_0$ . This motion of  $o_0$  corresponds to the curve (1) with a phase difference  $\pi/2$ .

This exchange does not change  $\Omega_1$ . But it transforms  $o_0$  into  $o_1$  into a dilated horizon  $2\Omega_1$ , with a velocity of rotation two times faster in the plan yz perpendicular to the initial plane xy (figure 12b).

A second spinback of  $o_0$  on  $\Omega_1$  (figure 12b), two times faster than the previous (during the rotation  $\pi/4$  of  $\Omega_0$  in the plane xy), transforms  $o_0$ . This particle, which became  $(o_0)_1$ , becomes  $o_2$  in the center of a dilated horizon  $4\Omega_2$ , in the plane xz, with a rate of rotation two times faster than the previous.

A third spinback of  $o_0$  on  $\Omega_1$  (figure 12c), two times faster than the previous (during the rotation  $\pi/8$  of  $\Omega_0$  in the plane xy), transforms  $(o_0)_1$ . This particle which became  $((o_0)_1)_2$ , becomes  $o_3$  in the center of a dilated horizon  $8\Omega_3$ , in the plane xy, with a velocity of rotation two times faster than the previous.

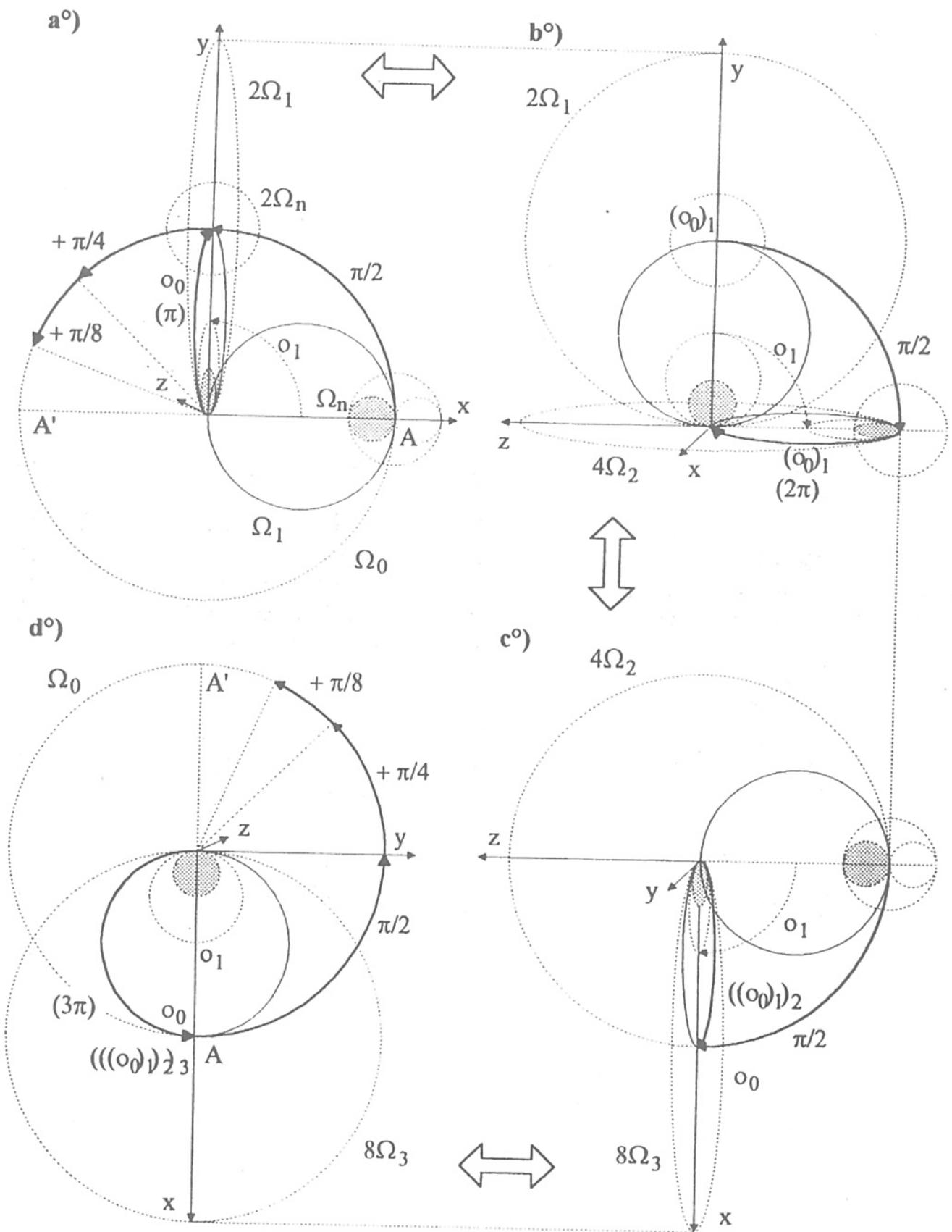

Figure 12 : three intermediate dilation.

## 6.5 Exchange Radial and Tangential Motion

After the tangential rotation  $(\pi - \pi/8)$  of the particle  $2\Omega_n$  on  $\Omega_0$ , the particle  $o_0$ , which became  $((o_0)_1)_2)_3 = o_0$ , is in A with a rate of rotation 8 times faster than the tangential spinback of  $\Omega_0$  (figure 13a). It is into the dilated horizon  $8\Omega_3$ , which ends its spinback in the center of the radial axis  $AA'$ .

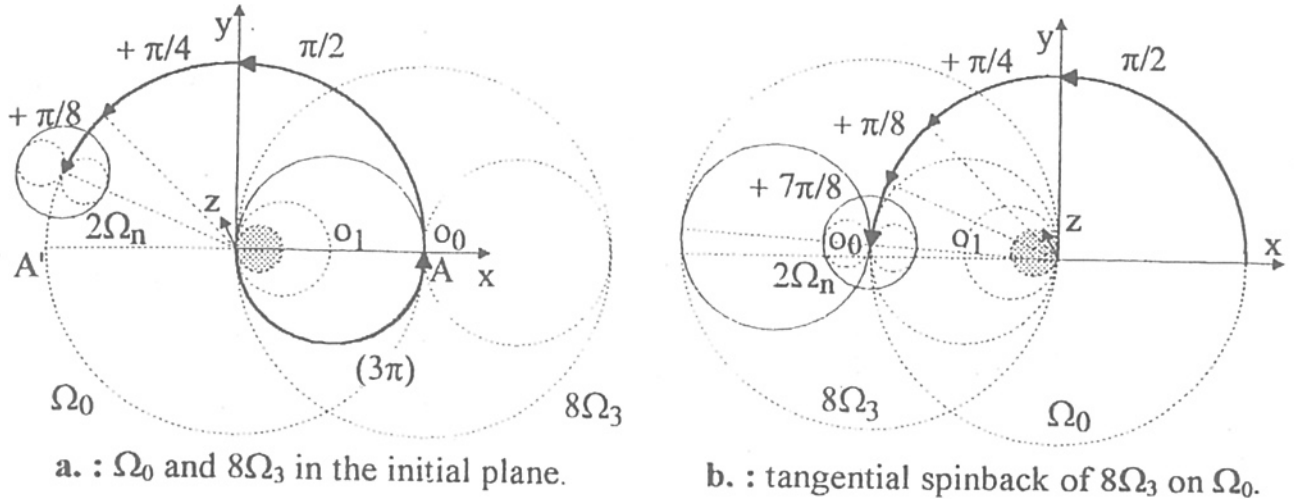

Figure 13 : spinback of  $o_0$  on  $\Omega_0$ .

The horizon  $8\Omega_3$  of the particle  $o_0$  can also make a tangential spinback on  $\Omega_0$  during the rotation  $\pi/8$  of the particle  $2\Omega_n$  on  $\Omega_0$  which ends its own spinback. So, it is possible to exchange radial and tangential motions after the rotation  $7\pi/8$  of  $2\Omega_n$  on  $\Omega_0$  and the rotation  $(\pi - \pi/64)$  of  $2\Omega_n$  on  $\Omega_0$ , that is to say before the end of spinbacks (figure 13b). By considering the horizon  $8\Omega_3$  as an initial horizon, the same motion can be realized after the rotation  $7\pi/8$  of  $2\Omega_n$  on  $\Omega_0$  and during the rotation  $\pi/16$  of  $2\Omega_n$  on  $\Omega_0$ . The spinbacks of  $\Omega_0$ ,  $8\Omega_3$  and  $63\Omega_6$  are completed with the exchange of radial and tangential motions when the initial horizon  $\Omega_0$  becomes the dilated horizon  $2\Omega_0$  (figure 14).

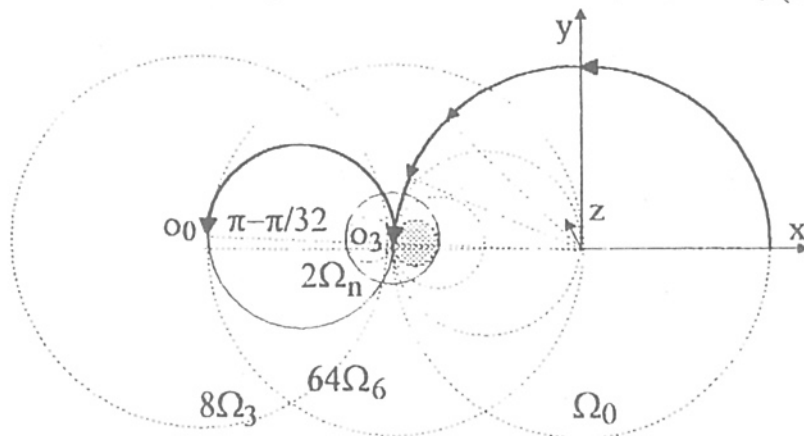

Figure 14 : exchange between radial and tangential paths.

This dilation allows the real particle  $o_0$  to exchange the flow of time and so become the external particle  $o_1$  of a horizon  $\Omega_{-1} = 2\Omega_0$ .

So, the intermediate particle  $o_3$  of the dilated horizon  $8\Omega_3$  can exchange the measure of the time of its horizon and the measure of the dimension of this horizon between the internal particle  $o_6$  of the dilated horizon  $64\Omega_6$  and the external particle  $o_{-1}$  of the dilated horizon  $\Omega_{-1}$ , according to the assumptions. So, the exchange of temporal holes into common horizons can be realized between the external particle  $o_0$  and the internal particle  $o_6$ . The intermediate particle  $o_3$  makes the connection. In fact, the external particle  $o_{-1}$  becomes  $o_0$  again in the initial plane at the end of this exchange.

### 6.6 Seven Embedded Particles-Horizons for Six Stroboscopic Times

These particles' exchanges need six intermediate stroboscopic times between seven embedded horizons. The anticipation and the first exchange are made in the 8<sup>th</sup> one. The 9<sup>th</sup> one makes the reverse exchange. So, we find the initial conditions again in the 10<sup>th</sup>. After the exchange, the 1<sup>st</sup> tangential spinback is the 10<sup>th</sup> radial spinback (figure 15). The external particle is the 7<sup>th</sup>, the intermediate is the 3<sup>rd</sup> and the internal is the 1<sup>st</sup>. When the doubling transformation ends, the seven horizons are juxtaposed. The particles' exchanges take place. After that, the next doubling transformation begins and the last 7<sup>th</sup> horizon becomes the next 1<sup>st</sup> particle. So, the last 7<sup>th</sup> particle becomes the past of the future 1<sup>st</sup> particle.

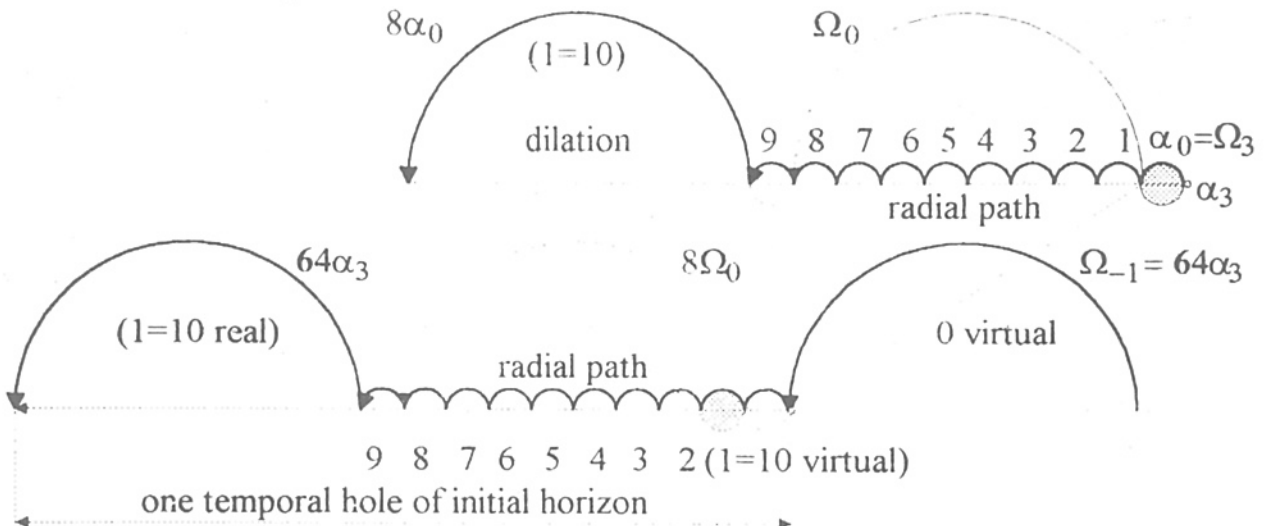

**Figure 15 :** radial and tangential paths' exchange between the three particles.

### 6.7 Condition and Exchange's Equation

Recall :  $R$  and  $\theta R$  are respectively the radius of the horizon  $\Omega_0$  and the tangential path of the particle  $o_0$  on  $\Omega_0$ .

$(R)_n$  or  $(\theta R)_n$  signify the value of  $R$  or  $\theta R$  observable in the horizon  $\Omega_n$ .

$(R_0)_1$  or  $(\theta_0 R_0)_1$  signify the value of  $(R)_0$  or  $(\theta)_0(R_0)$  observable in the horizon  $\Omega_1$ .

The spinback of a particle  $o_n$  is observable in its horizon  $\Omega_n$  only when :

$$(\theta)_n = (k)_n \pi. \quad \text{with } \theta = k\pi. \text{ and } k \text{ (whole)} \geq 0.$$

A spinback of a particle is observable outside any horizon only when the particle begins or ends its radial spinback into this horizon.

According to the above assumptions and conclusions, the exchange's condition between the particles is :  $(R/8)_1$  observable into the horizon of the intermediate particle  $o_1$ , can become  $(R)_2$  observable into the horizon of the internal particle  $o_2$ , if  $(2\theta R)_1$  observable into  $\Omega_1$  corresponds to  $(\theta R)_0$  observable into  $\Omega_0$ . And we can write :

$$(R/8)_1 = (R)_2 \quad (1)$$

$$(2\theta R)_1 = (\theta R)_0 \quad (2)$$

With (1) and (2), the exchange between the particles  $o_0$  and  $o_2$  will be possible when :

$$(R)_2 = ((R)_{-1})_0 = (R_{-1})_0. \quad (3)$$

with  $(\theta)_n = (k)_n\pi, \forall n$ ,

the relations (1), (2) and (3) imply the exchange's equation :

$$(\theta R^2)_1 = (4\theta R R_{-1})_0 \quad (4)$$

This equation (Garnier-Malet J.P. 1998) will be possible by using a change of spaces' and times' scales,  $(e_d)$  and  $(e_t)$ , so that :

$$e_t = 1/e_d = 2\pi^{1/2} \quad (5)$$

$$(4R)_0 = e_d\pi(R)_1 \quad (5')$$

$$(\theta^2)_0 = e_t(\theta)_1 \quad (5'')$$

The relation (5) is so that :  $e_t e_d = 1$ .

Between two successive horizons, the scale's exchange  $e_d$  (relation 5') transforms a radial path  $R$  into a tangential path  $\pi R$ , and the scale's change  $e_t$  (relation 5'') transforms  $\theta$  into  $\theta^2$ , or  $(k)_1\pi$  into  $(k)_0\pi^2$  during their common spinbacks.

When  $(k)_1$  equals  $(k^2)_0$ , the radial path  $R$ , during the time of one internal spinback ( $\pi$ ) is equal to the radial path  $R^2$  during the time of one spinback ( $\pi^2$ ).

In the embedded horizons systems of the doubling transformation :

$$(k)_1 = 2^3 = 8 \quad \text{and} \quad (k^2)_0 = 2^6 = 64$$

According to the hypothesis (dilation, acceleration, juxtaposition), that corresponds to the first spinback of the external horizon if :

$$(k)_{-1} = 2^0 = 1$$



An easy calculation (Garnier-Malet J.P., 1999) gives us the three radial velocities  $C_0$ ,  $C_1$ , and  $C_2$ , which are necessary for the initial and final juxtapositions of the three embedded particles or horizons  $\alpha_0$ ,  $\alpha_1$  and  $\alpha_2$ . This embedding uses what are six different stroboscopic times. The final exchange (figure 16), needs a dilated horizon  $(\Omega)_1$  with a radial velocity  $C_0$  (so that :  $C_0 = 7C_1$ ).

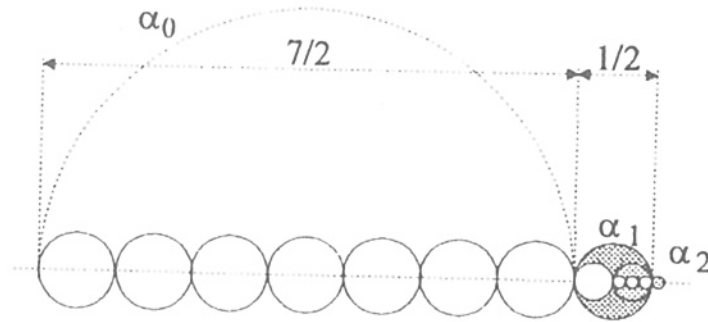

**Figure 16 : initial and final juxtapositions**

The final juxtaposition corresponds to the different value of  $(k)_0\pi$ ,  $(k)_1\pi$  and  $(k)_2\pi$  (figure 17). In order to verify the different assumptions, we must find numbers which are multiples of 6, 8, and 10 (six stroboscopic times, eight internal spinbacks, and an acceleration of spinbacks from 1 to 10) for the initial and final juxtapositions. So, we can write :

$$C_0 = 7C_1 = 7(49/12)10^5C_2. \tag{6}$$

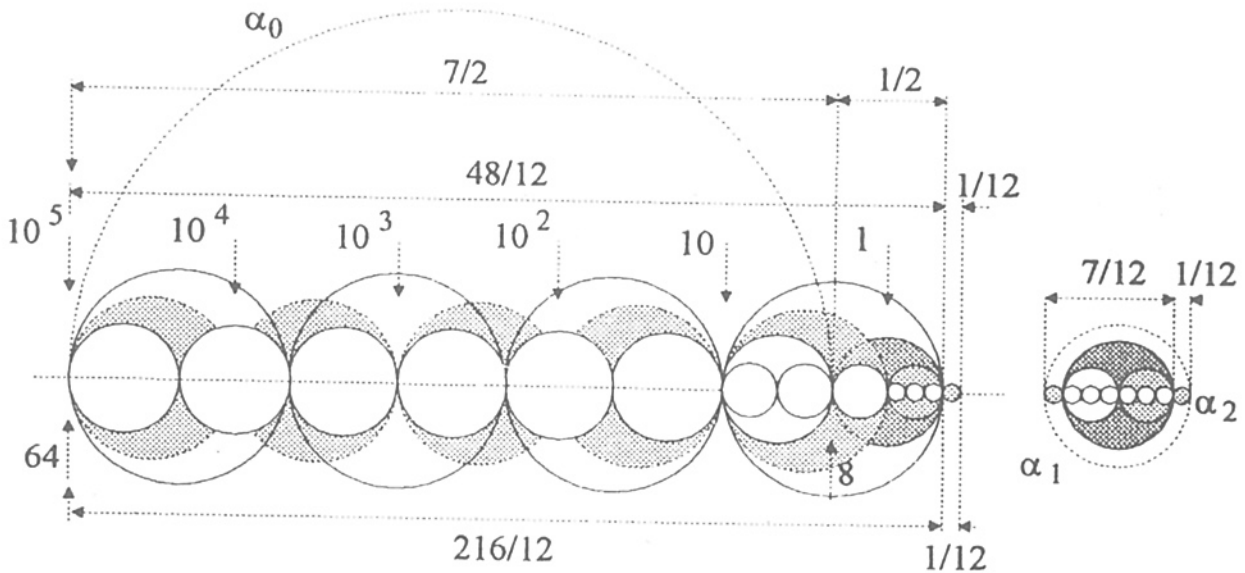

**Figure 17 : The three velocities of the horizons' exchanges**

$C_2$  is the maximum radial velocity of the smallest particle, which is observable into the third intermediate horizon  $\alpha_2$ , during the time of the doubling transformation. Because of the exchange scale ( $5''$ ), when  $\theta$  becomes  $\theta^2$  outside, it becomes  $\theta^{1/2}$  inside.

The common multiple values of  $(k^2\pi^2)_0$ ,  $(k\pi)_1$  and  $(k^{1/2}\pi^{1/2})_2$  and the numbers of spinbacks of the internal, intermediate and external particles or horizons (figure 17) imply the radial velocity  $C_2$  of  $\alpha_2$  so that :

$$C_2 = 54 \pi^{5/2}(\pi r/\tau)10^6 = (216\pi R_S/\tau)10^4 = 299\,792 \text{ km./sec.} \quad (7)$$

$R_S$  is the radius of the Sun and  $R_T$  is the radius of the Earth, so that :

$$R_S = (100/16)(\pi^{5/2})R_T \quad \text{and} \quad R_T = 4r = 6376 \text{ km.}$$

Two spinbacks' time of the Earth =  $2\tau = 365,25 \times 24 \times 3600 \text{ sec.} = \text{one year.}$

$\pi r$  is the radial spinback of  $\alpha_2$  into  $\alpha_1$ .  $r$  is the radius of the particle  $\alpha_2$ .  $\tau$  is the time of 4 tangential spinbacks of  $\alpha_2$  on  $2\alpha_1$  (figure 27).  $\tau$  is time of 1 radial spinback of  $\alpha_1$  into  $2\alpha_1$  during the tangential spinback of  $2\alpha_1$  on  $\alpha_0$ .  $\tau$  is also the time of 8 radial spinbacks of  $\alpha_1$  into  $\alpha_0$  during the tangential spinback of  $2\alpha_1$  on  $\alpha_0$ .

## 7 Theorem of the Three Horizons of Doubling

### 7.1 Hypothesis

To build the "Threefold Frame of Reference", there are three embedded particles : internal  $\alpha_2$ , intermediate  $\alpha_1$ , external  $\alpha_0$ . Each particle  $\alpha_n$  has a radial velocity  $V_n$  and a tangential velocity  $U_n$  (figure 18). The intermediate particle  $\alpha_1$  ends its spinback when the internal particle  $\alpha_2$  ends its radial path into this intermediate particle.

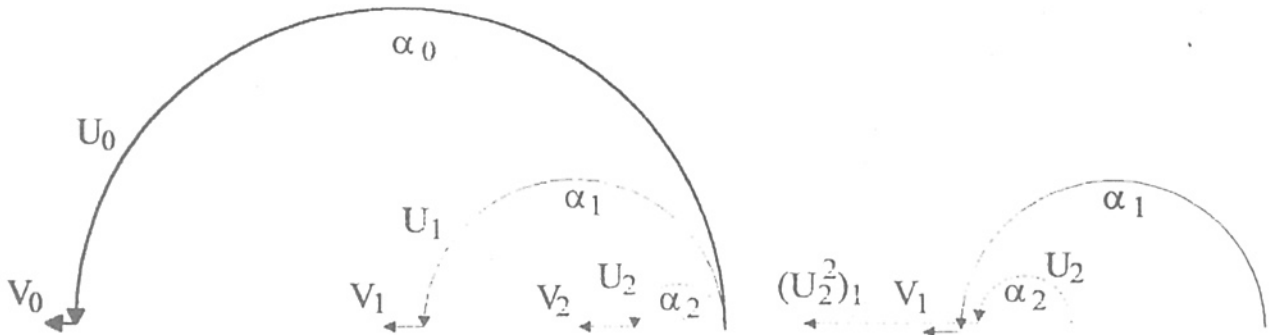

Figure 18 : the three embedded particles.

We saw the relationships (paragraph 6.7) :

$$e_t = 1/e_d = 2\pi^{1/2} \quad (5)$$

$$(4R)_0 = e_d\pi(R)_1 \quad (5')$$

$$(\theta^2)_0 = e_t(\theta)_1 \quad (5'')$$

The relationship (5'') transforms  $(\theta)_1$  into  $(\theta^2)_0$ , or  $(k)_1\pi$  into  $(k)_0\pi^2$ , during their common spinbacks. We saw that the embedded particles  $\alpha_1$  and  $\alpha_2$  are such that :

$$(k)_2 = 2^3 = 8 \quad \text{and} \quad (k^2)_1 = 2^6 = 64$$

and, into the particle  $\alpha_1$  (horizon of  $\alpha_2$ ), the radial path  $R_2$  which is made during the time  $T_2$  of one internal spinback  $\pi$ , must equal the radial path  $(R_2^2)_1$  which is made during the time  $(T_2^2)_1$  of one spinback  $\pi^2$ .

Consequently, the tangential velocity  $(\pi R_2/T_2)$  becomes  $(\pi R_2/T_2)_1^2$ .

But, at the same time, the scale's exchange (5') transforms  $\pi R_2$  (the tangential path) into  $R_1$  (the radial path), and the relation (5) allows us to make the simultaneous scale's exchanges ( $e_t$  and  $e_d$ ) without modifying the observations ( $e_t e_d = 1$ ).

So, the tangential velocity  $(\pi R_2/T_2)$  becomes the radial velocity  $(R_1/T_2)_1^2$ .

In other words, in the same time  $T_2$  or  $(T_2^2)_1$ , the tangential velocity  $U_2$  (into the particle  $\alpha_2$ ) becomes the radial velocity  $(V_2^2)_1$  into the particle  $\alpha_0$  (figure 30).

The time  $T_2$  (or  $T_0$ ) corresponds to the spinback of the particle  $\alpha_2$  (or  $\alpha_0$ ) during its radial path (figure 19)

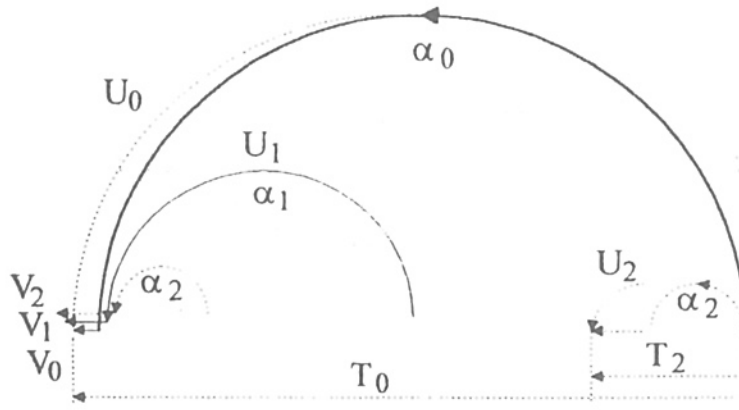

**Figure 19** : juxtaposition of the particles.

So, we can write :

$$V_0 = 8U_0 = (V_1)_0 = (U_1^2)_0 = (U_1)_1 = (1/8)(V_1)_1 = (1/8)(U_2^2)_1,$$

$$V_0/8 = (1/8^2)(U_2^2)_1 = (U_2/8)_2$$

So in the particle  $\alpha_1$ , the radial velocity  $V_0$  equals to the tangential velocity  $U_2$  which becomes  $(U_2^2)_1$  into  $\alpha_2$ . But the radial velocity  $V_0$  is also  $(U_1^2)_0$ .

Finally that implies :

$$(T_2^2)_1(U_2^2)_1 = (T_0^2)_1[(U_2^2)_1 - (U_1^2)_1]. \quad (8)$$

## 7.2 Relativity of Time in the Intermediate Particle or Horizon

This equation gives the relativity of the time in the intermediate particle  $\alpha_1$  between the external particle  $\alpha_0$  and the internal particle  $\alpha_2$ . In a particle, the radial velocity  $V$  is always equal to the tangential velocity  $8U$ . So, only into  $\alpha_1$ , the equations become :

$$[T_2^2 U_2^2 = T_0^2 (U_2^2 - U_1^2)]_1. \quad (8)$$

$$[T_2^2 V_2^2 = T_0^2 (V_2^2 - V_1^2)]_1. \quad (8')$$

## 7.3 Theorem

We can state the following and fundamental theorem :

A doubling transformation needs three particles (internal, intermediate and external), embedded into seven stroboscopic times which determine a Threefold Frame of Reference. The internal particle is into the first and fast stroboscopic time. The intermediate particle is into the third and intermediate stroboscopic time. The external particle is into the seventh and slow stroboscopic time.

The initial and final condition must transform the first tangential spinback of the internal particle  $\alpha_2$  into 999 radial spinbacks of its horizon  $\alpha_1$ . This horizon  $\alpha_1$  is a particle : it uses 666 spinbacks into its horizon  $\alpha_0$ , which, at its turn, uses 333 spinbacks to becomes  $\alpha_1$  into the dilated horizon  $\Omega_1 = 2\Omega_0$ .

## 7.4 Demonstration

We must find now the value of  $(k)_0\pi$ ,  $(k)_1\pi$ , and  $(k)_2\pi$ , which verifies the equations (8), (8') and (8'') during the initial and final juxtapositions and the particles' exchanges.

The 999<sup>th</sup> spinback of the internal particle  $\alpha_2$  (figure 20) ends the third juxtaposition of the intermediate particle  $\alpha_1$  and the first juxtaposition of the external particle  $\alpha_0$ .

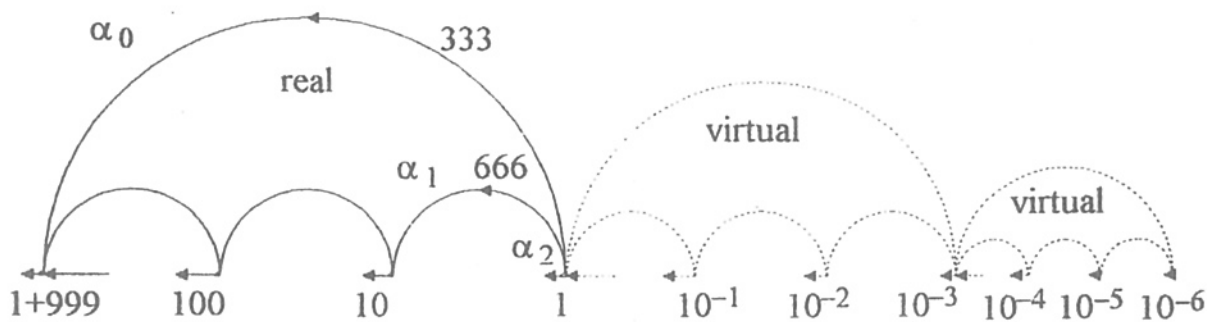

Figure 20 : the two virtual initial particles

So, the real first spinback of  $\alpha_2$  into  $\alpha_1$ , must be the 1000<sup>th</sup> of 999 virtual spinbacks.

The third juxtaposition dilates  $\alpha_1$  into  $2\alpha_1$ . So, these 999 virtual spinbacks must come from intermediate spinbacks ( $2/3=666$ ) and external spinbacks ( $1/3=333$ ).

We saw that  $\pi R$  inside the particle corresponds to  $\pi^2 R^2$  outside.

The  $(333/1000)$  spinbacks of the two virtual particles, outside  $\alpha_0$ , are such that :

$$(333/1000)^2 = (10^{-1}+10^{-2}+10^{-3})(1-10^{-3}) \quad (9)$$

This condition is to exchange the radial virtual path and the real tangential path.  
 This initial condition verifies the final condition at the end of the spinback of  $\alpha_0$  :

$$1/1000 + 333/1000 + 666/1000 = 1 \quad (10)$$

So, 999 real radial spinbacks (internal) come back at the first time and become 666 intermediate spinbacks and 333 external spinbacks just before the end of the spinback of  $\alpha_0$  (figure 21), during a common temporal hole.

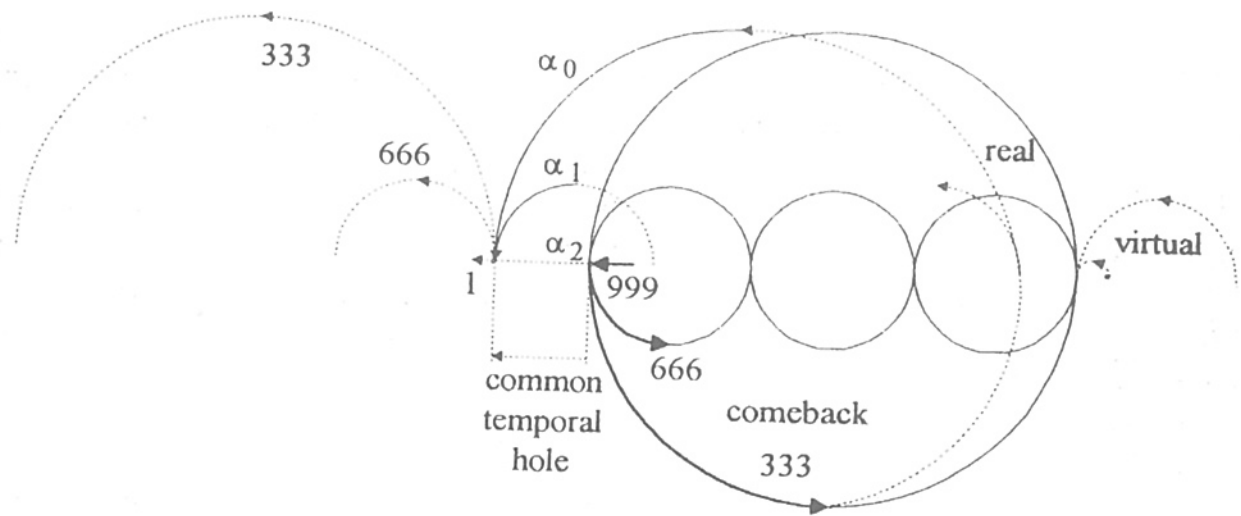

Figure 21 : the comeback during the common temporal hole.

### 7.5 Verification by Observations in Our Universe (January 1998)

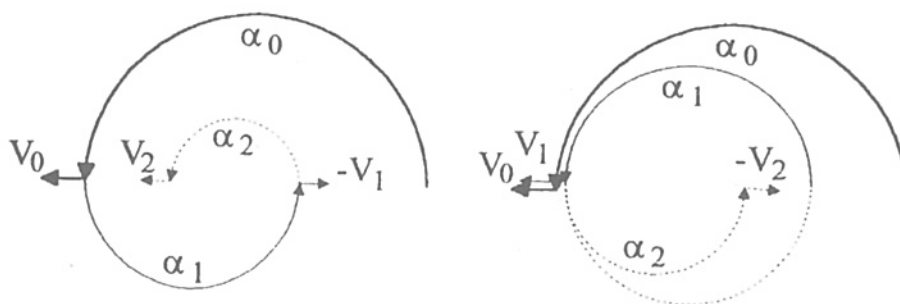

Figure 22 : the embedding.

Before the final juxtaposition of the three particles, the three radial velocities of the three embedded particles are not always in the same direction (figure 22).

We saw that the observable radial velocity  $V$  into the intermediate particle, is always the square  $U^2$  of the tangential velocity  $U$  of the internal or external particle.

In other words, this observable radial velocity seems to be resulting from an external or internal energy, which is proportional to the square of a velocity.

We can say that the proportion of the initial or final spinbacks between the three embedded particles is also the proportion of the three energies, which are necessary to their doubling motions.

At the end of the doubling transformation, the final juxtaposition again gives the initial conditions with the same proportions :

1/1000 : internal particle,  
666/1000 : intermediate particle,  
333/1000 : external particle,

which are also the proportions of the three embedded energies.

We will call :

$E_R$ , the energy of "rayonnance 333" (from radius in French) of the internal particle.

$E_C$ , the energy of "coherence 666" of the intermediate particle, because the time of its spinback determines the length of radial axis.

$E_R$ , the "unitary external energy" of the external particle during its spinback. At the end of its spinback, it becomes the new virtual energies of "rayonnance 333" and "coherence 666" of the next spinback, according to the equation (9) :

$$(333/1000)^2 = (10^{-1} + 10^{-2} + 10^{-3})(1 - 10^{-3})$$

So, just before the end of the first spinback of the external particle (before the common temporal hole), the energy of "coherence 666" is opposed to the energy of "rayonnance 333" on the radial axis (figure 22).

Recently, by two different observations of supernovae, two scientists (Saul Permuter in America and Brian Schmidt in Australia, January 1998) demonstrated that the expansion of the Universe is accelerated by an unknown energy of repulsion or anti gravitation, which is opposite to the energy of gravitation. This energy would be 70% of the Universe's energy. With the above theorem of the three doubling horizons, I can say that this energy is not 70/100 but 666/1000 of the energy initial  $E_i$  of our Universe.

This energy (which is the energy of coherence  $E_C$ ) is observable at the end of the doubling. It seems to correspond to an acceleration of the dilation (or expansion) of the internal particle.

During the doubling, the energy of "coherence 666" is not observable because the energy of "rayonnance 333" seems to be the energy which gives a cohesion to the intermediate horizon. In the same way, 9/10 of the internal spinbacks (figure 15 and 20) are not observable into the intermediate horizon before the end of the doubling.

That could explain the missing masses (9/10) which would correspond to the virtual (or apparently missing) spinbacks.

This new energy (repulsion or anti gravitation) is not a new energy which would be the result of a negative mass, but the consequence of exchanges of energies by final

juxtaposition of the three embedded horizons : the energy of coherence becomes the energy of rayonnance of the external observer and reversibly in a non-perceivable time. An application of the fundamental motion to the solar system (Garnier-Malet J.P., 1997), allows us to understand that this energy (expansion) becomes perceivable : the six stroboscopic solar horizons are beginning their juxtaposition and the final dilation (expansion) of the Universe is now appearing.

The acceleration of the expansion of the Universe, which is limited by the time of this juxtaposition, proves that we are really at « the end of the times » (that is to say : the six stroboscopic times of doubling). So, the theorem of the three horizons, which is the « theorem of the coherence and of the rayonnance » of any doubling space, can explain many of the observations in the cosmos.

## 7.6 The Three Velocities of Juxtaposition (Garnier-Malet, 1998)

### 7.6.1 The speed of light

Into the solar system (which is anticipatory embedded systems) the Earth, (associated with Saturn : Garnier-Malet, 1998), is a particle of the third horizon. I could calculate the speed of light (radial velocity) into this intermediate horizon with the relation (7) :

$$C_2 = 10^4 \cdot 216\pi R_S / \tau = 299\,792 \text{ km./sec.}$$

$R_S$  is the radius of the Sun and  $2\tau$  is one year ( $365,25 \times 24 \times 3600$  sec.).

### 7.6.2 The Time of the Solar Temporal Hole (24 835 years = 100 years of Pluto)

The time of  $(12 \times 216)$  spinbacks of the Earth's particle corresponds to  $(1/2) \times (217)$  spinbacks of its solar horizon (Garnier-Malet, 1998, 1999) :

$$T(\text{Earth}) = (12 \times 216) - (1/2) \times (216 + 1) = 2\,483,5 \text{ spinbacks of the Earth's particle.}$$

With the acceleration (from 1 to 10), the time of the solar doubling is :

$$10T(\text{Earth}) = 25\,920 - 1085 = 24\,835 \text{ years}$$

That corresponds to 200 spinbacks of the horizon of Sun-Pluto.

The Pluto year (2 spinbacks) corresponds to 248,35 years.

The time of 25 920 years is the time of the rotation of the polar axis of the Earth during the time of 1 085 years which is the time of the rotation of its solar horizon.

### 7.6.3 The Radial Path of the Universe's Temporal Hole (14,815<sup>9</sup> light years)

The equation (6) allows us to calculate the time of the Universe's temporal hole which corresponds to the radial path of our light in the time of the solar doubling cycle (Garnier-Malet, 1999). In fact, this equation (6) :

$$C_0 = 7C_1 = 7(49/12)10^5 C_2.$$

defines the flows of time into three successive embedded horizons or particles.

During 2/10 (dilation 2 and radial acceleration 10) of 25920 years (solar cycle of our light or radial path of the mini particle), the Universe light (tangential path of maxi horizon) used only  $2 \times 1085$  years. So, we can say that the Universe's age is :

$$(2/10) \times 25920 \times (7 \times 49/12) 10^5 = 14,818 \cdot 10^9 \text{ light years}$$

minus the final and the virtual initial anticipation ( $2 \times 1085$  years) :

$$(2/10) \times (25920 - 2 \times 1085) \times (7 \times 49/12) 10^5 = 13,583 \cdot 10^9 \text{ light years.}$$

1085 light years is the common boundary between the first horizon and the last particle.  $13,583 \cdot 10^9$  light years correspond to 3 spinbacks of the Universe because the solar system is between  $4,6 \cdot 10^9$  and  $4,5 \cdot 10^9$  years old, so that :

$$4,510 \times 3 = 13,583.$$

## 8 Conclusion

The fundamental motion allows any particle to dispose of a new frame of reference (Threefold Frame of Reference or TFR). With it, an external particle can anticipate a future event into the horizon of an internal particle and introduce this future into the horizon of an intermediate particle. Because of this hyperincursion of its future into its past, this intermediate particle obtains an instantaneous past, according to its future. So, its present event is always a reflex time resulting from this hyperincursion.

The horizon of a physical observer could be juxtaposed with the virtual particles' horizons during a temporal hole. So, a physical observer could anticipate the future.

In the next years (may be 2017-2020, before the theoretical date 2079), it will be the end of the solar cycle (Garnier-Malet J.P. 1998) : the solar explosion (1989, march the 13th) is the 4<sup>th</sup> of the seven explosions which are necessary to balance the six stroboscopic times of our six solar particle (Sun-Pluto, Mercury-Neptune, Venus-Uranus, Earth-Saturn, Asteroids' belt and Kuiper's Belt) in their own horizon.

These six embedded solar horizons are the consequences of the fundamental motion of doubling, which implies the above new theorem of three horizons or of three energies.

The acceleration of the expansion of the Universe, observed by Brian Schmidt and Saul Perlmutter (January 1998) and the resulting discovery of a new energy of repulsion (anti-gravitation) confirms this theorem.

At the end of the solar cycle, we will observe the final juxtaposition of the six embedded particles or horizons (solar, galactic and universal) which will correspond to the juxtaposition of the six embedded solar particles-horizons.

During the solar cycle of 24835 years,  $13,583 \cdot 10^9$  light years is the distance which is made by our light (with the light speed 299 792 km/sec).

This distance is observable by the solar observer but not by the virtual galactic or universal observer.



These two virtual observers – virtual universal observer  $o_0$  (speed  $C_0$ ), virtual galactic observer  $o_1$  (speed  $C_1$ ) and real human observer  $o_2$  (speed  $C_2 =$  speed of light) – build our Threefold Frame of Reference (TFR), according to the initial hypothesis.

At the end of the doubling transformation of our anticipatory embedded solar system, the juxtaposition of the seven horizons will give us the observation of the Universe outside the universal temporal hole, inside the temporal window of the two virtual observers.

The seven stroboscopic times, which are necessary for the solar doubling transformation of 24835 years, will balance. Then, another solar doubling transformation will begin and the seven stroboscopes of time will start again for 24835 years, according to 12 periods of 2070 years...

Between these two cycles, it is difficult to forecast the future of our planet if we ignore the end of the six solar stroboscopic times and if we don't pay attention to the consequences of this end.

## References

- Einstein A. 1921, Princeton, First of the Four Conferences : Theory of the Relativity.
- Rosen Robert, 1985, Anticipatory systems, Pergamon Press.
- Dubois Daniel M., 1996, Introduction of the Aristotle's Final Causation in Cast : Concept and Method of Incursion and Hyperincursion. Eurocast 95. Ed. By Pitcher, R Moreni Diaz, R Albrecht. Lectures Notes in Computer Science Volume 1030, Springer-Verlag, Berlin, Heidelberg, New York pp. 477-493.
- Dubois Daniel M., 1990, Le Labyrinthe de l'Intelligence, InterEditions/Academia-Louvain-Paris, (2<sup>ème</sup> ed.).
- Abbot Larry, 1998, Le Mystère de la Constante Cosmologique, Pour la Science n° 249.
- Krauss.L.M. 1998, The End of the Age Problem and the Case for a Constant Revisited, Astrophysical Journal, vol. 501, n°2.
- Garnier-Malet J.P., 1998, Modelling and Computing of Anticipatory Embedded Systems : Application to the Solar System (Speed of Light). International Journal of Computing Anticipatory Systems, Volume 2, pp. 132-156, Ed. By D.M. Dubois, Publ. By CHAOS, Liège, Belgium.
- Garnier-Malet J.P., 1999, Geometrical Model of Anticipatory Embedded Systems : International Journal of Computing Anticipatory Systems, Volume 3, pp.143-159, Ed. By Dubois D.M., Publ. By CHAOS, Liège, Belgium.